

# Wheel Dumpers



**WACKER  
NEUSON**



# The following points are strong arguments in favor of the wheel dumpers from Wacker Neuson

## 1. Tackle challenges - and easily master them

You may not be able to choose the terrain, but you can choose the machine! Even on the most difficult of terrains, Wacker Neuson's wheel dumpers can carry out any task. The articulated pendulum joint provides high off-road capability and excellent traction on any surface.

## 2. The best conditions for performance – a strong hydrostatic drive system

Technologies must prove themselves in action every single day. The wheel dumpers from Wacker Neuson are equipped with high-quality drive systems, which provide reliable performance and will impress with their user-friendly operation for many years to come.

## 3. Flexibility and reliability – the hallmark of our wheel dumpers

The wheel dumpers from Wacker Neuson are not only durable, sturdy and extremely reliable, but can also be used universally, thanks to a large amount of configuration options. Different types of skips and other options allow the machine to be configured to your needs. These include everything from air conditioning in the cab to the Speed version. We will be happy to advise you and ensure that each of your wheel dumpers provides you with reliable and powerful transportation of material.

# Transport expertise down to the last detail

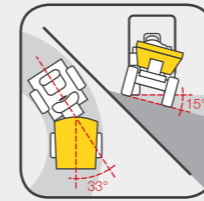

## Travel effortlessly over any terrain

Neither narrow passages nor uneven surfaces can stop the wheel dumpers from Wacker Neuson: thanks to the articulated pendulum joint, they can go anywhere!

Read more on page 12.



## Drive without shifting gears

With the pedal, everything is under control: the hydrostatic drive system makes driving simple and makes switching unnecessary in many cases.

See page 13 details.

## telematic

## Locate wheel dumpers anytime

With the global monitoring system, you can always determine the exact location of your machines.

## Always the right skip

Thanks to the front, high and swivel tip skips, the wheel dumpers are well-prepared for any application. An overview of all skip versions can be found on page 12.



## Full safety with cab or roll over protective structure

Choose between the safety cab with ROPS/FOPS Level II with integrated heating, optional air conditioning, the roll over protective structure (ROPS), and a practical awning.

Read more on page 11.



# All wheel dumpers in overview.



1001

Maximum payload:

1000 kg



1501

1500 kg



1601

1500 kg

> Page 04



2001

2000 kg



3001

Maximum payload:

3000 kg



4001

4000 kg

> Page 06



5001

5000 kg



DW60

6000 kg



DW90

9000 kg

> Page 08



DW100

10000 kg

All details about our wheel dumpers are also available online at:  
[www.wackerneuson.com/dumper](http://www.wackerneuson.com/dumper)

# Wheel dumpers up to 2 tons

Whether off-road or in extremely narrow passages: the small wheel dumpers from Wacker Neuson will win you over with their compact design, maneuverability, and equipment options for efficient operations.

- Low-maintenance hydrostatic twin-lock all-wheel drive (1001, 1501, and 2001) for the best traction
- Excellent off-road capability thanks to articulated steering (33°) and oscillating angle (15°)
- Good service access
- Three skip versions (front, swivel, and high)

**The twin lock all-wheel drive** ensures good traction.

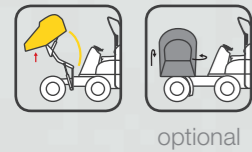

1501



**Three skip variations** at good value for money.

1601



— optional —

**Ultra-compact:** available from a width of 990 mm with narrow tires.

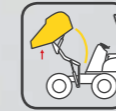

1001



**Maximum flexibility:** can be equipped with a self-loading device.



2001



	1001	1501	1601	2001
Max. payload (kg)	1000	1500	1500	2000
Engine output (kW/HP)	17/23.1	17/23.1	17/23.1	22.5/30.6
Width (mm)	1180	1305	1305	1485

**The compact design** also allows for working in tight spaces.



**Fold-down roll over protective structure** is ideal for low headroom or during transport.



**Stable on any terrain** thanks to the articulated pendulum joint.



**Independent loading without further machines** – with the self-loading equipment.



# Wheel dumpers from 3 to 5 tons

Extremely simple to use and can be loaded with large volumes: with this combination, you are sure to be impressed by the wheel dumpers in this weight class.

- Low-maintenance hydrostatic all-wheel drive
- Excellent off-road capability thanks to articulated steering (37°) and oscillating angle (15°)
- Rapid transport tasks possible, thanks to speeds of up to 25 km/h
- Safe mounting and alighting from control stand on either side.

**Speed versions**  
up to 25 km/h

	3001	4001	5001
Max. payload (kg)	3000	4000	5000
Engine output (kW/HP)	24/32.7	34.1/46.1	47.5/64.6
Width (mm)	1785	1795	1920



3001

**Maximum safety** and operational strength in any weather, thanks to the optional cab.

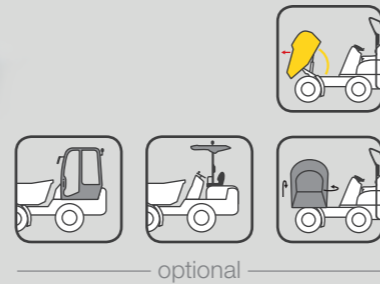

4001

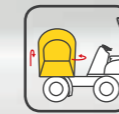

5001

**The most compact of its class** – even on narrow construction sites, it can go anywhere.



optional



# Wheel dumpers from 6 to 10 tons

The dumpers in the DW series help you to get material under way, even on difficult terrain. Even at high volumes, you can always rely on these heavyweights of wheel dumpers. You will also be impressed by the long maintenance intervals of 500 operating hours and low operating costs – perfect for rental yards!

- Low-maintenance hydrostatic all-wheel drive with the ECO Mode
- Various skip versions: front and swivel tip
- Easily removable safety cab with optional air conditioning
- Completely wear-free operation of the spring-loaded parking brake for absolute durability and reliability
- All models meet the applicable exhaust emission directives:
  - DW60: Level IIIb/Tier IV final
  - DW60: Level IIIa/Tier III (for LRC\*)
  - DW60 Power, DW90, DW100: Level IIIb/Tier IV interim

\* Low regulation countries



**Professional for**  
particularly heavy loads.

**DW100**



	DW60	DW90	DW100
Max. payload (kg)	6000	9000	10000
Engine output (kW/HP)	55/75	86/117	86/117
Width (mm)	2250	2465	2465



**DW60**

**Available on request as a power version**  
with higher engine output.

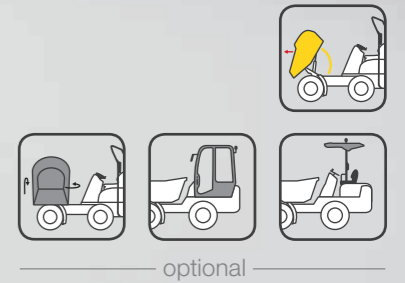

**DW90**

**For even more options:**  
ex-factory optional swivel tip skip

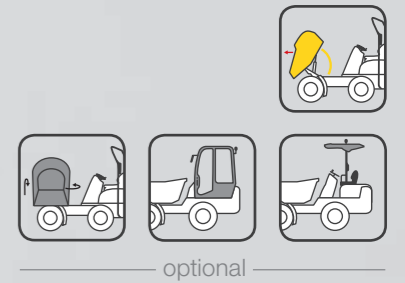

**Lateral maintenance cover is comfortably accessible from the ground** for convenient control and increased safety.



**Impressive in every situation,** thanks to high ground clearance.



**Safe, simple, and fast:** more safety when folding down the roll over protective structure, thanks to the practical gas pressure shock absorber.



**Practical and flexible:** it has a robust rear with retractable taillights.



## Control stand and operating concept

The operating concept applies to: DW60, DW90, and DW100

An innovative operating concept for the control stand and seating console: all operator's controls, such as switches, the joystick or the display, are placed on the right-hand side. The left hand can thus always remain on the steering wheel!

- Joystick for safe and convenient operation
- Vandalism protection for increased service life of the components
- Display with service indicator for better planning
- Front-view camera, rear view mirror, and optimal lighting for excellent visibility
- Powerful heater and air conditioning system for maximum comfort

The lockable vandalism protection safeguards the control elements and the display screen on the control stand.



Diverse functions, one handle: with the joystick for dump operation, gear shift, change of travel direction, and ECO mode



Extremely simple operation: brake-inch pedal on the left, gas pedal on the right.



## Tires

The special tires are available for: DW60

The best tires for each challenge: in addition to the standard tires with tractor profile, for the DW60, you will also receive our universal tires with good traction and quiet running, as well as turf tires for low ground pressure.



**AS tread**  
Standard tires for maximum traction.



**MPT tread**  
Wide range of applications: ideal for fast road crossings and uneven terrain.



**RP tread**  
Perfect for lawns: the large contact surface protects the soil.



## Cab

A cab is available for: 3001 DW60, DW90, DW100

Particularly advantageous in the rain or cold: wheel dumpers with a cab enable the operator to work comfortably all year long.

- Heated safety cab with optional air conditioning system (from DW60)
- Plenty of head and legroom for the operator
- Optimum all-round visibility for safe working
- ROPS/FOPS Level II certified
- The cab can be removed from the DW60 for easy transportation



The optional air conditioning provides the perfect working temperature for optimal air circulation



**Removable safety cab** with mountable ROPS: for transportation or use in any weather.

# Skips

Whether for construction, gardening and landscaping, or municipal use: the three skip types are designed for different needs and provide exactly the qualities that are in demand.

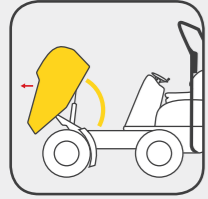

### Front tip skip

The front tip skip is ideal for transporting a lot of material within a short timeframe.

- For larger volumes of material
- Low center of gravity and low dumping height
- Economical solution



### High tip skip

If you need to bridge differences in height, the high tip skip is the right choice for you.

- Suitable for container loading
- Dumping height of up to 1.45 m
- Flexible use as front or high tip skip

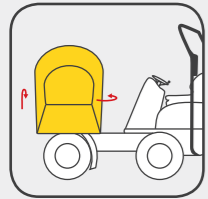

### Swivel tip skip

Thanks to the infinitely variable 180° tipping, the swivel tip skip puts your material exactly where you want it – ideal for limited spaces.

- Leveling during transport of liquids on slopes
- 2 x 90° swing gear left and right
- Sideways filling possible

Front tip skip



High tip skip



Swivel tip skip



## Hydrostatic all-wheel drive

Just hop on and go: with the hydrostatic all-wheel drive, the operator can concentrate on work instead of switching gears. Ideal for rental yards or frequently changing operators.

- A central hydraulic motor, which drives a cardan shaft on both axles
- Very easy to use because there are no frequent gear changes
- Hydrostatic braking effect as soon as the foot is removed from the gas pedal
- Wear-resistant drive system for low service and maintenance costs



A central hydraulic motor for both axles.

Hydrostatic all-wheel drive is available for: 3001 4001 5001 DW60, DW90, and DW100



## Twin lock all-wheel drive

On highly uneven surfaces, one wheel loses traction at some point and rotates freely. The twin lock all-wheel drive system from Wacker Neuson responds quickly: each of the four wheels has its own hydraulic motor, which is always optimally distributed.

- All-wheel drive with its own hydraulic motor
- Easy maintenance and cost savings because no changing of gear oil and brake fluid is necessary

Twin lock all-wheel drive is available for: 1001 1501 and 2001

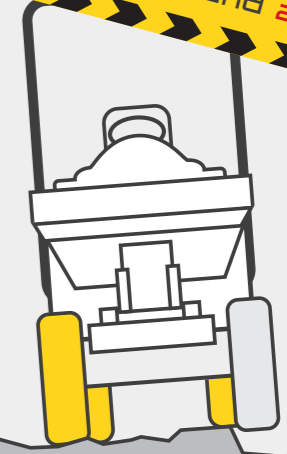

# Self-loading device

Quickly fill the skip with a large volume of material, all without the use of other machines: the self-loading device makes work easy and helps save valuable time.

- For lifting material weighing up to 300 kg
- Loading arm and shovel can be operated independently

Within seconds, the material is loaded into the skip.



## Articulated pendulum joint

In many applications, rough terrain with bumps, small inclines, and bottlenecks is a part of daily operations. For this reason, all wheel dumpers from Wacker Neuson are equipped with an articulated pendulum joint.

- Excellent off-road capability, even under load
- Depending on the model, articulated pendulum steering up to 37°/15°
- Best ground contact and excellent traction

Permanent grip, even when tilted.



# Configuration possibilities

WHEEL DUMPERS

	1001	1501	1601	2001	3001	4001	5001	DW60	DW90	DW100
<b>SKIP</b>										
Asphalt skip	-	-	-	-	○	-	-	-	-	-
Swivel tip skip	-	○	○	●	○	●	●	○	○	-
Front tip skip	-	-	●	-	●	-	-	●	●	●
High tip skip	●	●	○	-	-	-	-	-	-	-
Light-material skip	-	-	-	-	-	○	-	-	-	-
3 m skip (CH)	-	-	-	-	-	-	-	○	-	-
Self-loading device	-	-	-	○	-	-	-	-	-	-
Special skip	-	-	-	○	-	-	-	-	-	-
<b>CAB</b>										
Cover for instruments (with canopy)	○	○	○	○	○	○	○	○	○	○
Cabin (standard)	-	-	-	-	○	-	-	○	○	○
Air conditioning system	-	-	-	-	-	-	-	○	○	○
Complete radio kit	-	-	-	-	○	-	-	○	○	○
Awning	-	-	-	-	○	-	○	○	○	○
<b>HYDRAULICS</b>										
BP-Biohyd SE46	○	○	○	○	○	○	○	○	○	○
Panolin HLP Synt46 (Bio)	○	○	○	○	○	○	○	○	○	○
<b>ENGINE AND DRIVE SYSTEM</b>										
Turbo diesel engine Tier IV closed DPF	-	-	-	-	-	-	-	○	●	●
Turbo diesel engine Tier IV open DPF	-	-	-	-	-	-	-	○	-	-
25 km/h version	-	-	-	-	-	○	●	●	●	●
28 km/h version	-	-	-	-	-	-	-	○	-	-
30 km/h version	-	-	-	-	-	-	-	-	○	○
<b>TELEMATICS</b>										
Telematic Europe 12 months	○	○	○	○	○	○	○	○	○	○
Telematic Europe 24 months	○	○	○	○	○	○	○	○	○	○
Telematic Europe 36 months	○	○	○	○	○	○	○	○	○	○
Telematic Europe 48 months	○	○	○	○	○	○	○	○	○	○
Telematic Europe 60 months	○	○	○	○	○	○	○	○	○	○
Telematic Europe 72 months	○	○	○	○	○	○	○	○	○	○
<b>PAINT</b>										
Custom paint on machine no RAL	○	○	○	○	○	○	○	○	○	○
Custom paint on cab/canopy RAL	-	-	-	-	○	-	-	○	○	○
Custom paint on machine RAL	○	○	○	○	○	○	○	○	○	○
<b>EXTENDED WARRANTIES:</b>										
Security 24 P (2000 h)	○	○	○	○	○	○	○	○	○	○
Security 24 C (2000 h)	○	○	○	○	○	○	○	○	○	○
Security 24 PH (2000 h)	○	○	○	○	○	○	○	○	○	○
Security 36 C (3000 h)	○	○	○	○	○	○	○	○	○	○
Security 36 P (3000 h)	○	○	○	○	○	○	○	○	○	○
Security 36 PH (3000 h)	○	○	○	○	○	○	○	○	○	○
<b>TIRES</b>										
Tractor profile	●	●	●	●	●	●	●	●	●	●
Turf tires	-	-	-	-	-	-	-	○	-	-
Narrow tires	○	-	-	-	-	-	-	-	-	-
Mitas MPT 03 special tires	-	-	-	-	○	○	○	○	-	-

● Standard ○ Option - not suitable

WHEEL DUMPERS

	1001	1501	1601	2001	3001	4001	5001	DW60	DW90	DW100
<b>MISCELLANEOUS</b>										
Hitch	●	●	●	●	●	●	●	○	○	○
Running lights	-	-	-	-	-	-	-	○	○	○
Fluid film	○	○	○	○	○	○	○	○	○	○
Manufacturing confirmation	○	○	○	○	○	○	○	○	○	○
Cold start capability (increased)	-	-	-	-	-	-	-	○	○	○
Wheel chock	-	-	-	○	○	○	○	○	○	○
Seat contact switch	-	-	-	-	-	-	-	○	○	○
Plug receptacle for vehicle hitch	○	○	○	○	○	○	○	○	○	○
STVO-accessories	○	○	○	○	○	○	○	○	○	○
TÜV approval for road use (GER)	○	○	○	○	○	○	○	○	○	○
KAT engine immobilizer	○	○	○	○	○	○	○	○	○	○
<b>SECURITY</b>										
Front and rear work lights	-	-	-	-	○	-	-	○	○	○
Mirrors (rear view mirror)	○	○	○	○	○	○	○	○	○	○
Back-up alarm	○	○	○	○	○	○	○	○	○	○
Rotating beacon	○	○	○	○	○	○	○	○	○	○
Protective grating for front windshield	-	-	-	-	○	-	-	-	-	-
Vision camera	-	-	-	-	○	○	○	○	○	○

## Security

The highest degree of safety combined with maximum comfort: the wheel dumpers from Wacker Neuson meet all European safety standards and offer numerous features that make the work comfortable.



**All cabs** satisfy FOPS Level. 2 The 3001 is also available with a protective grille.



**The back-up alarm** provides an acoustic signal when the machine is in reverse.



**Working lights:** two forward-facing headlights and one reverse-facing headlight, and complete road lighting for optimal visibility.



**Rotating beacon** for better visibility of the machine.



**Two exterior mirrors** for maximum visibility.



**The vision camera** minimizes the blind spot in front of the machine, thus ensuring further safety.

# Dimensions

WHEEL DUMPERS

		1001	1001	1501	1501	1601	1601	1601	2001	2001	2001	3001	
			Narrow	High tip skip	Swivel tip skip	High tip skip	Swivel tip skip	Front tip skip	Swivel tip skip	SLE	Low skip	Swivel tip skip	
GENERAL	UNIT												
A	Overall length	mm	3080	3080	3300	3220	3300	3220	3310	3420	3530	3420	4140
B	Wheel base	mm	1500	1500	1650	1700	1650	1700	1700	1800	1800	1800	1960
C	Tail projection	mm	810	810	810	810	810	810	810	880	880	880	1160
D	Front dumping width	mm	770	770	840	710	840	710	800	740	850	740	1020
E	Dumping width	mm	510	510	400	280	400	280	370	350	-	-	600
F	Width of vehicle	mm	1180	990	1305	1305	1305	1305	1305	1485	1485	1485	1785
G	Width of skip	mm	1130	990	1200	1260	1200	1260	1300	1470	1470	1470	1775
H	Overall height of ROPS	mm	2580	2580	2550	2550	2550	2550	2550	2650	2650	2650	2670
I	Height ROPS folded	mm	1850	1850	2000	2000	2000	2000	1960	1850	1850	1850	1870
J	Height of cab	mm	-	-	-	-	-	-	-	-	-	-	2610
K	Height of skip Dumping edge tipped	mm	465/1560	465/1140	370/1450	705	370/1450	705	360	1090	1090	-	1020
L	Height of skip Upper edge tipped	mm	1770/ 2860	1770/ 2440	1895/ 2975	2240	1895/ 2975	2240	1970	3000	3000	2550	3125
M	Height of skip Upper edge not tipped	mm	1230	1230	1345	1310	1345	1310	1345	1400	1400	1400	1475
N	Dumping width lateral	mm	-	-	-	100	-	100	-	180	180	180	245
O	Ground clearance	mm	270	270	270	270	270	270	260	380	380	380	280

WHEEL DUMPERS

		3001	3001	4001	4001	5001	DW60	DW60	DW60	DW90	DW90	DW100	
		Front tip skip	Low skip	Swivel tip skip	Swivel tip skip	Swivel tip skip	Swivel tip skip	Swivel tip skip	Swivel tip skip	Swivel tip skip	Front tip skip	Front tip skip	
GENERAL	UNIT												
A	Overall length	mm	3980	4140	4200	4200	4390	4935	4575	4770	5185	4760	4760
B	Wheel base	mm	1960	1960	1960	1960	2110	2485	2485	2485	2700	2700	2700
C	Tail projection	mm	1160	1160	1215	1215	1150	1190	1190	1190	1190	1190	1190
D	Dumping width front	mm	860	1020	1025	1025	1130	1160	800	995	1195	770	770
E	Dumping width	mm	577	600	600	600	625	505	610	490	480	555	555
F	Width of vehicle	mm	1785	1785	1795	1795	1920	2250	2250	2250	2465	2465	2465
G	Width of skip	mm	1860	1775	1740	1740	1990	2090	2330	2090	2275	2495	2490
H	Overall height of ROPS	mm	2670	2670	2700	2700	2830	3110	3110	3110	3355	3165	3355
I	Height ROPS folded	mm	1870	1870	1930	1930	2030	2300	2300	2300	2545	2355	2545
J	Height of cab	mm	2610	-	-	-	-	2998	2998	2998	3245	3055	3245
K	Height of skip Dumping edge tipped	mm	260	1020	1030	1030	1160	1080	460	1175	1170	495	495
L	Height of skip Upper edge tipped	mm	2220	2200	3200	3200	3630	3525	2490	3525	3865	2755	2755
M	Height of skip Upper edge not tipped	mm	1475	1475	1500	1500	1790	2075	2020	2075	2305	2250	2300
N	Dumping width lateral	mm	-	245	270	270	250	115	-	100	190	-	-
O	Ground clearance	mm	280	280	300	300	290	369	369	369	406	406	406

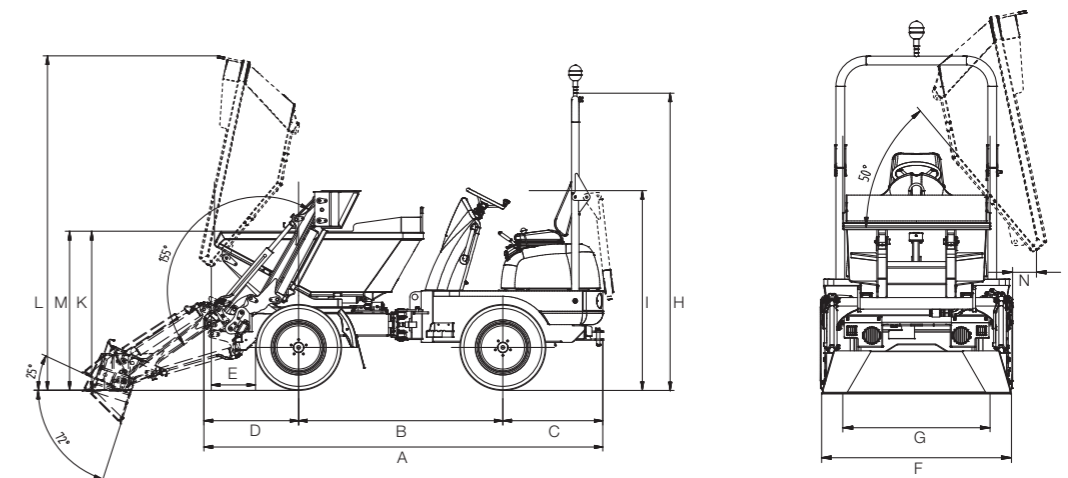
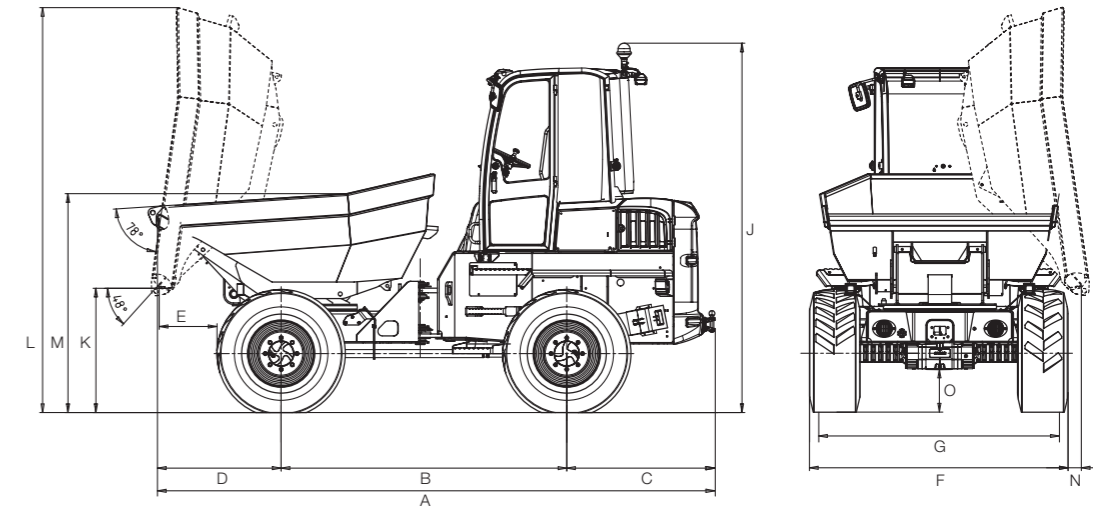
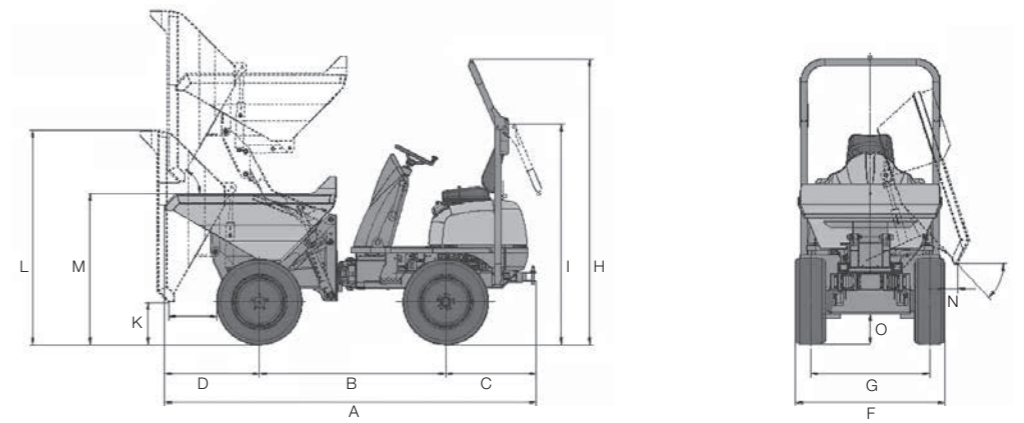



# Everything for your project.



**WACKER  
NEUSON**

Wacker Neuson offers you a complete range of solutions of powerful quality products combined with services that support in any situation.

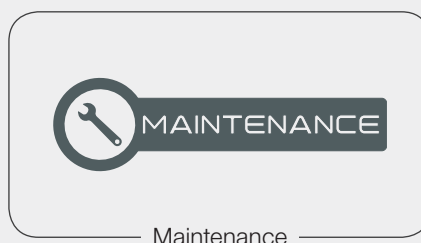
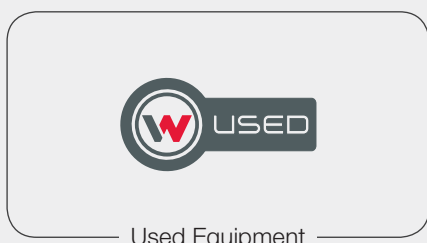
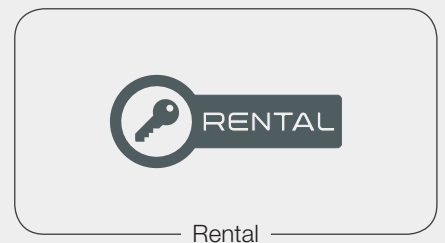
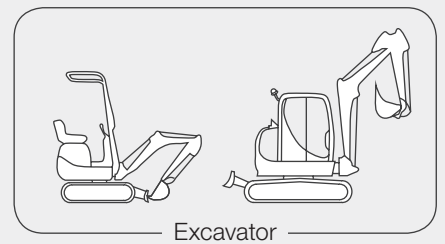
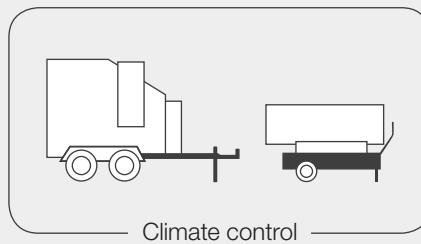
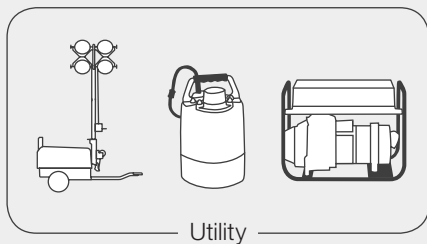
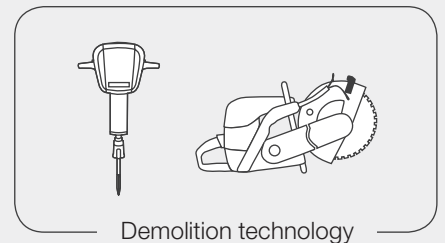
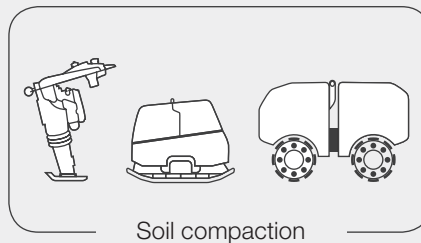
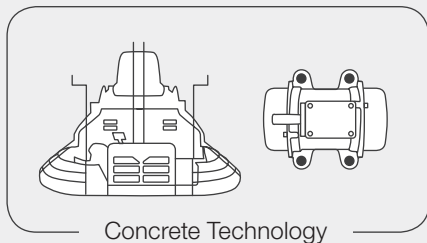

[www.wackerneuson.com](http://www.wackerneuson.com)